



LEOPARD FAMILY

TL

Leopard Series Transmitter



An economically smart programmable transmitter relay with isolated 4 to 20 mA retransmission or control loop output capability for measurement and control applications.

General Features

- External transmitters or signal conditioners can be eliminated by direct connection of the sensor output to more than 38 Plug-in Input Signal Conditioners that include:
 - AC/DC Current – Pressure – Resistance
 - AC/DC Voltage – Process – *Temperature
 - Load Cell – Prototype – 4 to 20 mA
- *See models TLH for higher accuracy digitally linearized thermocouple and RTD
- Isolated 16 bit analog output. User or factory scalable to 4 to 20 mA, 0 to 20 mA or 0 to 10 V across any desired digital span from ± one count to the full scale range of – 1999 to 9999 (12000 counts).
- Auto-sensing AC/DC power supply. For voltages between **85-265 V AC / 95-300 V DC (PS1)** or 15-48 V AC / 10-72 V DC (PS2).
- 24 V DC excitation is available to power external transmitters and 5 or 10 V DC excitation is available for resistance bridge type sensors such as Load Cells and Pressure Transducers.
- Automatic intelligent averaging smooths noisy signals, while providing a fast display response to real level changes.
- Remote Display Option only.

Software Features

- Three-button programming from the optional remote display (UP, DOWN and PROGRAM buttons).
- Front panel selectable four-level brightness control of digital display, and setpoint LEDs when display is used.
- Two programmable setpoints.
- Relay activation can be selected to occur above (HI) or below (LO) each setpoint.
- Hysteresis, Delay on make and delay on break for both setpoints.
- Peak and Valley. View and Reset.(only when display is used)

Input Module Compatibility

LEOPARD FAMILY: More than 38 different Plug-in **I-Series** Input Signal Conditioners are approved for Texmate's Leopard Family of meters. Some examples are shown on pages 8-10. See www.texmate.com for an up to date listing.



LEOPARD

Specifications

Input Specs: Depends on Input signal conditioner
A/D Converter: 14 bit single slope
Accuracy: ±(0.05% of reading + 2 counts)
Temp. Coeff.: 100 ppm/°C (Typical)
Warm up time: 2 minutes
Conversion Rate: 5 conversions per second (Typical)
Remote Display: **4 digit 0.56" Red LED Remote display. (Optional)**
 Range –1999 to 9999 counts.
Polarity: Assumed positive. Displays – negative
Decimal Selection: Front panel button selectable, X•X•X•X•
Positive Overage: Top segments of digital display flash
Negative Overage: Bottom segments of digital display flash
Relay Output: Two 9 Amp Form C relays.
Analog Output: Isolated 16 bit user scalable mA or V
 AIC (mA out) 4-20 mA @ 0 to 500Ω max loop resistance
 AIV (volts out) 0-10 V DC @ 500 Ω or higher resistance
Power Supply: AC/DC Auto sensing wide range supply
PS1 (std) **85-265 VAC 50-400Hz / 95-300 VDC @ 3.5W**
PS2 15-48 VAC 50-400Hz / 10-72 VDC @ 3.5W
Operating Temp.: 0 to 50 °C
Storage Temp.: –20 °C to 70 °C.
Relative Humidity: 95% (non condensing)
Case Dimensions: DIN Rail Mount
 22.5mm x 102.4mm x 128.7mm
 (Width x Height x Depth)
 Plus 11.8 mm (0.47") for Right-angled connectors.
Weight: 6.5 oz., 8.5 oz when packed

Index

Case Dimensions 12	Digital Span Selection for	Input Module Compatibility 1	Software Logic Tree.3
Connector Pinouts 7	Analog Range Output 5	I-Series Input Signal	Specifications.1
Controls and Indicators 2	Functional Diagram 7	Conditioning Modules 8-10	Two Point Analog Output
Decimal Point & Brightness	General Features.1	Ordering Information 14	Range Setting and Calibration5
Selection 5	Glossary of Prog. Symbols 2	Setpoint Setting & Relay	
Digital Calibration Mode 4	Input Module Analog Cal. 11-12	Configuration Mode 6	
Digital Calibration Procedure. 4	Input Module Comp. Glossary. 11	Software Features 1	

Optional Remote Display for Field Programming and Setup is needed



Front Panel Buttons

Program Button

The **P** button is used to move from one program step to the next. When pressed at the same time as the **↑** button, it initiates the **calibration mode**. When pressed at the same time as the **↓** button, it initiates the **setpoint setting mode**.

Up Button

When in the operational display, pressing the **↑** button alone, allows you to view and reset the Peak and Valley (Highest and Lowest Readings.)

When in the **calibration mode** or the **setpoint setting mode** the **↑** button is used to increase the value of the displayed parameter.

Down Button

When in the operational display, pressing the **↓** button alone, allows you to view, but not change, the setting of setpoint 1&2.

When in the **calibration mode** or the **setpoint setting mode** the **↓** button is used to decrease the value of the displayed parameter.

Glossary of Programming Symbols

To explain software programming procedures, logic diagrams are used to visually assist in following the programming steps. The following symbols are used to represent various functions and associated display elements of the meter:

Symbol	Explanation
	This symbol represents the OPERATIONAL DISPLAY.
	This is the PROGRAM button.
	This is the UP button.
	This is the DOWN button.
	When a button is shown, press and release it to go onto the next step in the direction indicated by the arrow. When two or more buttons are shown, each with an arrow, this indicates that there is a number of programming choices.
	When two buttons are shown side by side and enclosed by a dotted line, they must be pressed at the same time then released to go onto the next programming step.
	If the display is shown with XXXX it means the value displayed will be the previously set value. When a number is shown it indicates the initial factory default setting or a specific "example number".

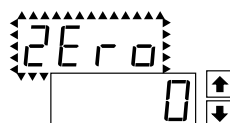

When two displays are shown together with bursts, this indicates that the display is toggling (flashing) between the name of the function and the value.

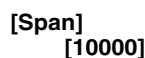

Text or numbers shown between square brackets in a procedure indicate the programming code name of the function or the value displayed on the meter display.



When the **↑** and **↓** buttons are shown together, the display value can be increased by pressing and releasing the **↑** button or decreased by pressing and releasing the **↓** button.



When the **↑** and **↓** buttons are shown with two displays, either display can be selected by pressing and releasing the **↑** or **↓** buttons.

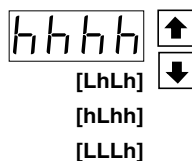

When there are more than two display selections they are shown in brackets below the first display and are also selectable by pressing and releasing the **↑** or **↓** buttons.

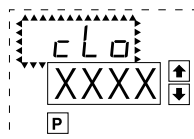

A dotted box indicates these functions are omitted or bypassed when the related hardware is not present

The TL is an intelligent transmitter with a hierarchical software structure designed for easy programming and operation, as shown below in the software logic tree.

After the meter has been powered up, the four digits light up for three seconds and then settle to the operational display indicating the input signal.

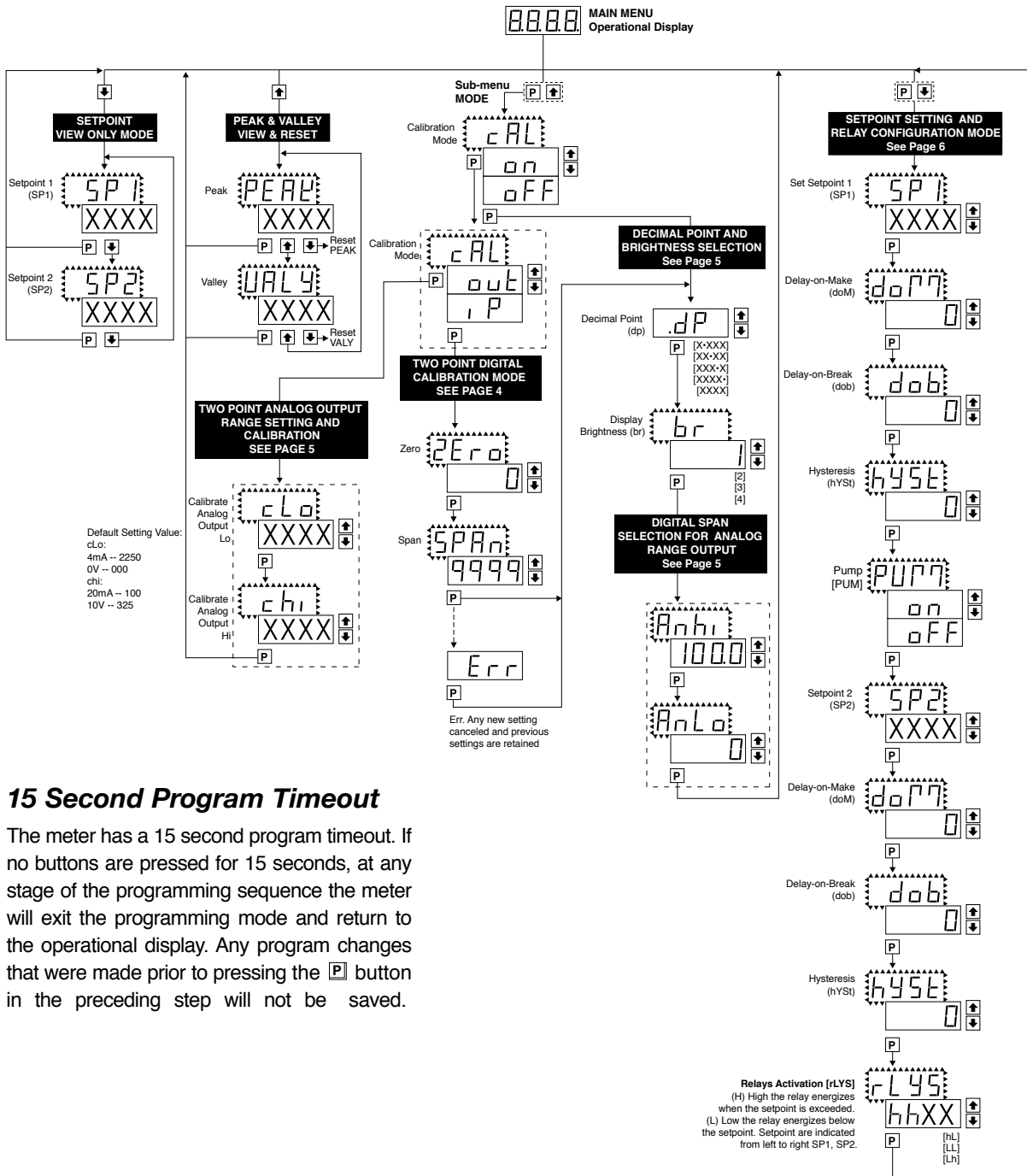

Pump On Pump Off
When PUM is selected ON, and SP2 is set at a value higher than SP1, the SP1 relay will operate in a special "pump on pump off" Hysteresis mode. SP2 acts as the upper limit and SP1 acts as the lower limit of the Hysteresis Band.

For filling applications, rLYS should be set to LhLh. SP1 will then activate for inputs less than the SP1 setpoint, and remain ON until the SP2 setpoint is reached.

For emptying applications, rLYS should be set to hhhh. SP1 will then activate for inputs greater than the SP2 setpoint, and remain ON until the SP1 setpoint is reached.

15 Second Program Timeout

The meter has a 15 second program timeout. If no buttons are pressed for 15 seconds, at any stage of the programming sequence the meter will exit the programming mode and return to the operational display. Any program changes that were made prior to pressing the [P] button in the preceding step will not be saved.

Digital Calibration Mode

This mode enables the meter to be calibrated with an automatic scale factor calculation, by applying a high input signal, entering the desired reading for that signal, then applying a zero or low input signal, and then entering the desired 0 or low reading. The meter then automatically calculates and programs in the requisite scale factor, within the following parameters.

1. Positive and negative signals may be applied, but the difference between the high and the low signal inputs must be at least 1000 counts or Err will be indicated.
2. Positive and Negative values for the desired reading can be entered, but the scale factor created can not exceed the Digital Display Span capability of the meter which is 12,000 counts between -1999 to 9999.
3. The internal Signal Span is limited to 3 V DC between -1 V DC to +2 V DC. Any outputs from an Input Signal Conditioning module that exceed these limits will cause the meter to indicate overrange regardless of the Digital Display Span scaled.

Note: Most input signal conditioners have provisions for analog calibration and scaling. If the meter's digital scale factor is set to read zero with a zero input (shorted input), and to read 1000 with a 1.000 V input, any pre-calibrated signal conditioner with an output that does not exceed -1 V to +2 V, will read correctly in the meter without any further calibration.

Digital Calibration Procedure

STEP A Enter the Calibration Mode

- 1) Press the **P** and **↑** buttons at the same time. Display toggles between [cAL] and [oFF].
- 2) Press the **↑** or **↓** button. Display changes from [oFF] to [on].
- 3) Press the **P** button. Display toggles between [ZEro] and the previous zero setting.

STEP B Select Between Two Point Digital Calibration of Input Signal and Two Point Analog Output

Note: If the analog output option is not present, Step B is skipped and the program goes directly from Step A to Step C.

- 1) Press the **↑** or **↓** button to select the display toggling from [cAL] to [iP] input calibration.
- 2) Press the **P** button. Display toggles between [ZEro] and the previous zero setting.

STEP C Set the Meter's Low Input Signal Reading on the Digital Display

- 1) Apply a zero or low signal to the meter. (Positive or negative values are allowed)
- 2) Using the **↑** and **↓** buttons, adjust the meter display to the desired reading for the applied low input signal.
- 3) Press the **P** button. Display toggles between [SPAN] and the previous span setting.

STEP D Set the Meter's High Input Signal Reading on the Digital Display

- 1) Apply a high input signal to the meter.
- 2) Using the **↑** and **↓** buttons, adjust the digital display to the desired reading for the applied high input signal.
- 3) Press the **P** button.

The Digital Calibration Procedure Mode is Now Complete.

If the digital calibration was successfully completed, the menu branches to the DISPLAY FUNCTION CONFIGURATION MODE, (see page 7) and the display flashes [dP] and the previous setting.

ERROR Indicates Unsuccessful Calibration

If the calibration was unsuccessful, the display indicates [Err], the new calibration settings just entered will not take effect and the previously stored setting will remain.

The three most likely causes of an error during calibration are:

- 1) The full scale and zero signals were too similar. The full scale signal must be at least 1000 counts greater than the zero or low input signal (positive and negative values are allowed).
- 2) The scaling requirement exceeded the capability of the meter (-1999 to 9999).
- 3) No input signal present, or incorrect connections.

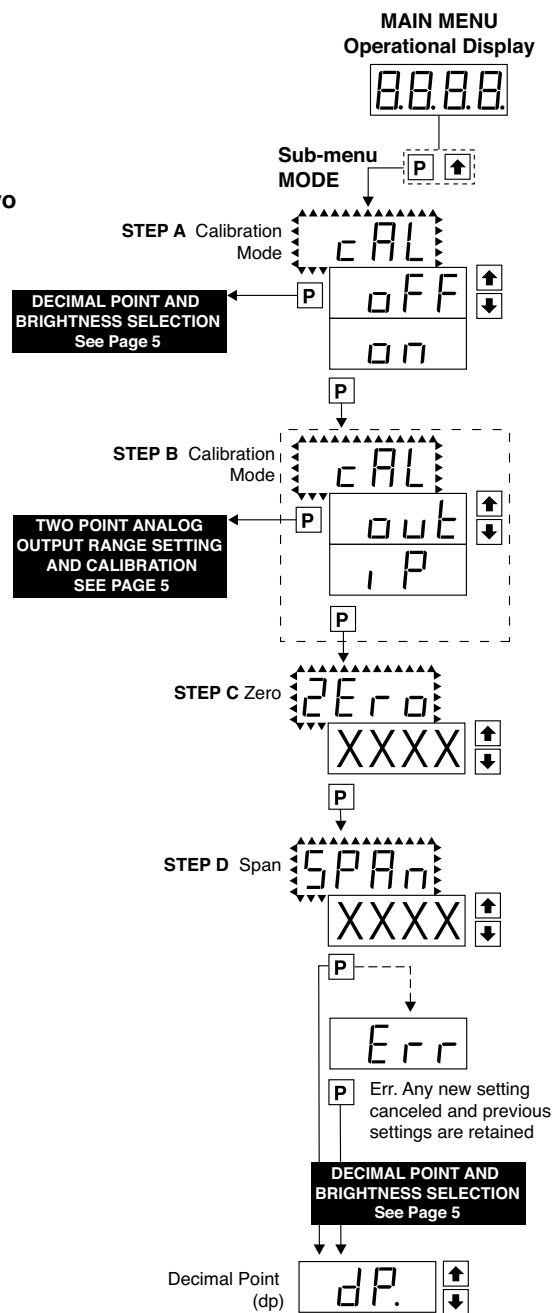

Two Point Analog Output Range Setting and Calibration

STEP A Enter the Calibration Mode

- 1) Press the **[P]** and **[↑]** buttons at the same time.
Display toggles between [cAL] and [oFF].
- 2) Press the **[↑]** or **[↓]** button. Display changes from [oFF] to [on].
- 3) Press the **[P]** button. Display toggles between [cAL] and [out] input calibration.

Note: If at this point the display skips directly to toggle between [SPAn] and the previous [SPAn], the software is detecting that the optional analog output hardware is NOT installed.

STEP B Enter the Analog [oUT] Output Mode

- 1) Press the **[P]** button. Display toggles between [cLo] and an internal scale factor.

STEP C Set or Calibrate the [cLo] Low Analog Output Range

- 1) Select the voltage or current loop output header position on the output module. (See Component Layout on page 9).
- 2) Connect a multimeter to pins 16 and 17 on the output module. (See Rear Panel Pinouts on page 8). Using the **[↑]** and **[↓]** buttons, adjust the analog output to the desired low value as shown on the multimeter display. cLo may be adjusted to any value from -0.3 mA to 17 mA (mA output selected) or from -0.6 V to 8 V (volt output selected)
- 3) Press the **[P]** button. Display toggles between [chi] and an internal scale factor.

STEP D Set or Calibrate the [chi] High Analog Output Range

- 1) Using the **[↑]** and **[↓]** buttons, adjust the analog output to the desired high value as shown on the multimeter display. chi may be adjusted to any value from 17 mA to 21 mA (mA output selected) or from 8 V to 10.3 V (volt output selected)
- 2) Press the **[P]** button. The display exits the calibration mode and returns to the operational display.

Note: Having established the Low and High range of the analog output, the digital span can now be selected which will set the two digital points between which the analog output will occur. (See Digital Span Selection below).

Decimal Point and Brightness Selection

Enter the Decimal Point and Brightness Mode Through the Sub Menu [CAL] [oFF]

- 1) Press the **[P]** and **[↑]** buttons at the same time.
Display toggles between [cAL] and [oFF].
- 2) Press the **[P]** button. Display shows previous [dp] selection.

STEP E Set the Decimal Point

- 1) Using the **[↑]** and **[↓]**, adjust the display to the desired decimal point setting.
- 2) Press the **[P]** button. Display toggles between [Br] and the previous [Br] setting.

STEP F Set the Display Brightness

- 1) Using the **[↑]** and **[↓]** buttons, adjust the display to the desired brightness setting (4 is the brightest setting).
- 2) Press the **[P]** button. Display brightness changes to new setting and display toggles between [Anhi] and the previous [Anhi] setting.

Digital Span Selection for Analog Range Output

STEP G Setting the Digital Span Point for Analog High Output

- 1) Using the **[↑]** and **[↓]** buttons, adjust the display to the desired digital value which sets the point at which the selected analog high output range will occur.
- 2) Press the **[P]** button. Display toggles between [AnLo] and previous [AnLo] setting.

STEP H Setting the Digital Span Point for Analog Low Output

- 1) Using the **[↑]** and **[↓]** buttons, adjust the display to the desired digital value which sets the point at which the selected analog low output range will occur.
- 2) Press the **[P]** button. The display exits the calibration mode and returns to the operational display.

Note: Any two digital scale points from -1999 to 9999 can be selected. The digital scale points for analog high and analog low can be reversed for reversed 20-4 mA output. The span of the digital scale can be as small as two counts however small spans cause the 16 bit D to A to increment in stair case steps.

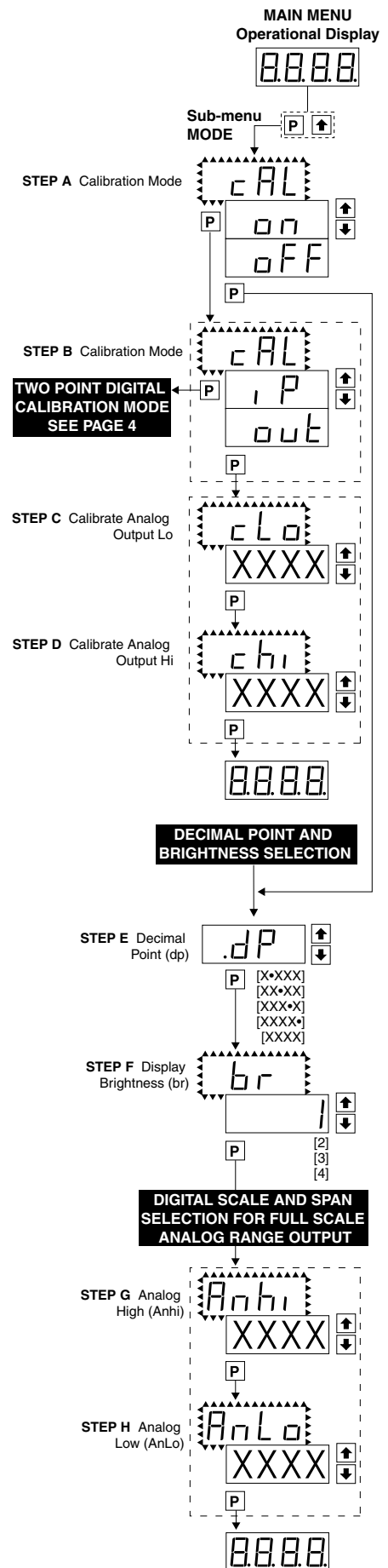

Setpoint Setting and Relay Configuration Mode

The following programming steps are required to enter the setpoint values and configure the relay functions in a meter with four relays using four setpoints. Generally if less than four relays are installed the software auto detects missing relays and deletes reference to them from the menu. In some cases setpoints without relays are operational for display only purposes.

STEP A Enter the Setpoint Mode

- 1) Press the **[P]** and **[↓]** buttons at the same time.
Display toggles between [SP1] and the previous [SP1] setting.

STEP B Set Setpoint 1 (SP1)

- 1) Using the **[↑]** and **[↓]** buttons, adjust the display to the desired SP1 value.
- 2) Press the **[P]** button. Display toggles between [doM] and the previous [doM] setting.

STEP C Set the SP1 Delay-on-Make (doM) Delay Time Setting

- 1) Using the **[↑]** and **[↓]** buttons, adjust the display to the desired [doM] value (0 to 9999 seconds). The reading must continuously remain in an alarm condition until this delay time has elapsed before the relay will make contact (energize).
- 2) Press the **[P]** button. Display toggles between [dob] and the previous [dob] setting.

STEP D Set the SP1 Delay-on-Break (dob) Delay Time Setting

- 1) Using the **[↑]** and **[↓]** buttons, adjust the display to the desired [dob] value (0 to 9999 seconds). The reading must continuously remain in a non-alarm condition until this delay time has elapsed before the relay will break contact (de-energize).
- 2) Press the **[P]** button. Display toggles between [hYSt] and the previous [hYSt] setting.

STEP E Set the Hysteresis Setting for Setpoint 1

- 1) Using the **[↑]** and **[↓]** buttons, adjust the display to the desired hysteresis [hYSt] value.
- 2) Press the **[P]** button. Display toggles between [SP2] and the previous [SP2] setting.

NOTE: Half of the Hysteresis value selected is applied above and below the setpoint.

NOTE: Steps G, H, I and J have functionally the same procedure as steps B, C, D, and E shown above.

STEP F Select Pump [PUM] (on) or (off)

- 1) Using the **[↑]** and **[↓]** buttons, select the Pump to be ON or OFF. When PUM is selected ON, and SP2 is set at a value higher than SP1, the SP1 relay will operate in a special "pump on pump off" mode. SP2 acts as the upper limit and SP1 acts as the lower limit of the Hysteresis Band on the SP1 relay.

For filling applications:

[rLYS] should be set to [LhXX] (see step M). The SP1 relay and SP1 LED Annunciator will then activate for inputs less than the SP1 setpoint, and remain ON until the SP2 setpoint is reached.

For emptying applications:

[rLYS] should be set to [hhXX] (see step M). The SP1 relay and SP1 LED Annunciator will then activate for inputs greater than the SP2 setpoint, and remain ON until the SP1 setpoint is reached.

- 2) Press the **[P]** button. Display toggles between [SP2] and the previous SP2 setting.

STEP G Set Setpoint 2 (SP2)

STEP H Set the SP2 Delay-on-Make (doM) Delay Time Setting

STEP I Set the SP2 Delay-on-Break (dob) Delay Time Setting

STEP J Set the Hysteresis Setting for Setpoint 2

- 1) Using the **[↑]** and **[↓]** buttons, adjust the display to the desired hysteresis [hYSt] value.
- 2) Press the **[P]** button. Display toggles between [SP3] and the previous [SP4] setting.

STEP K Set Relay Activation mode [rLYS]

(h) High the relay energizes when the setpoint is exceeded. (L) Low the relay energizes below the setpoint. The setpoint is indicated from left to right SP1, SP2.

- 1) Using the **[↑]** and **[↓]** buttons, adjust the reading on the display to the desired relay settings: [hh] [hL] [LL] [Lh].
- 2) Press the **[P]** button.

The meter exits the setpoint mode and returns to the operational display.

The Setpoint Relay programming mode is now complete.

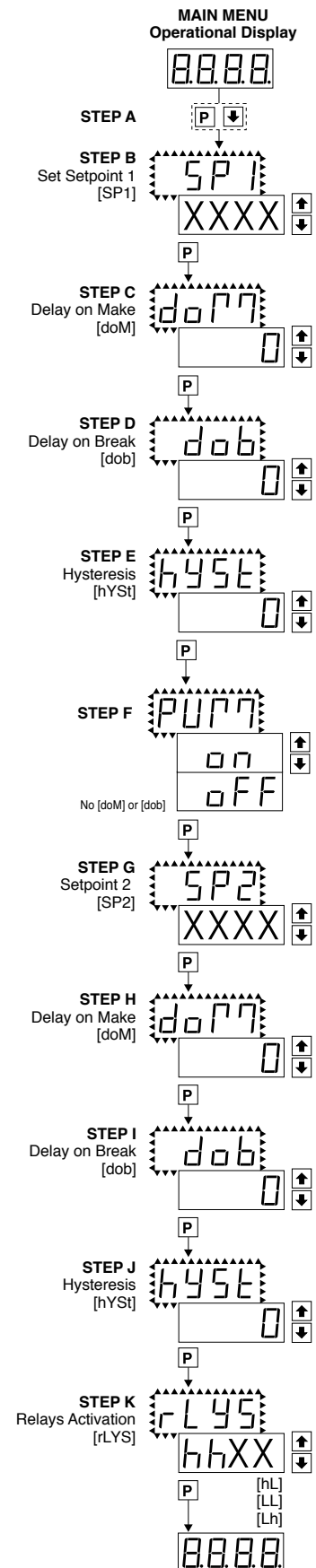

Functional Diagram

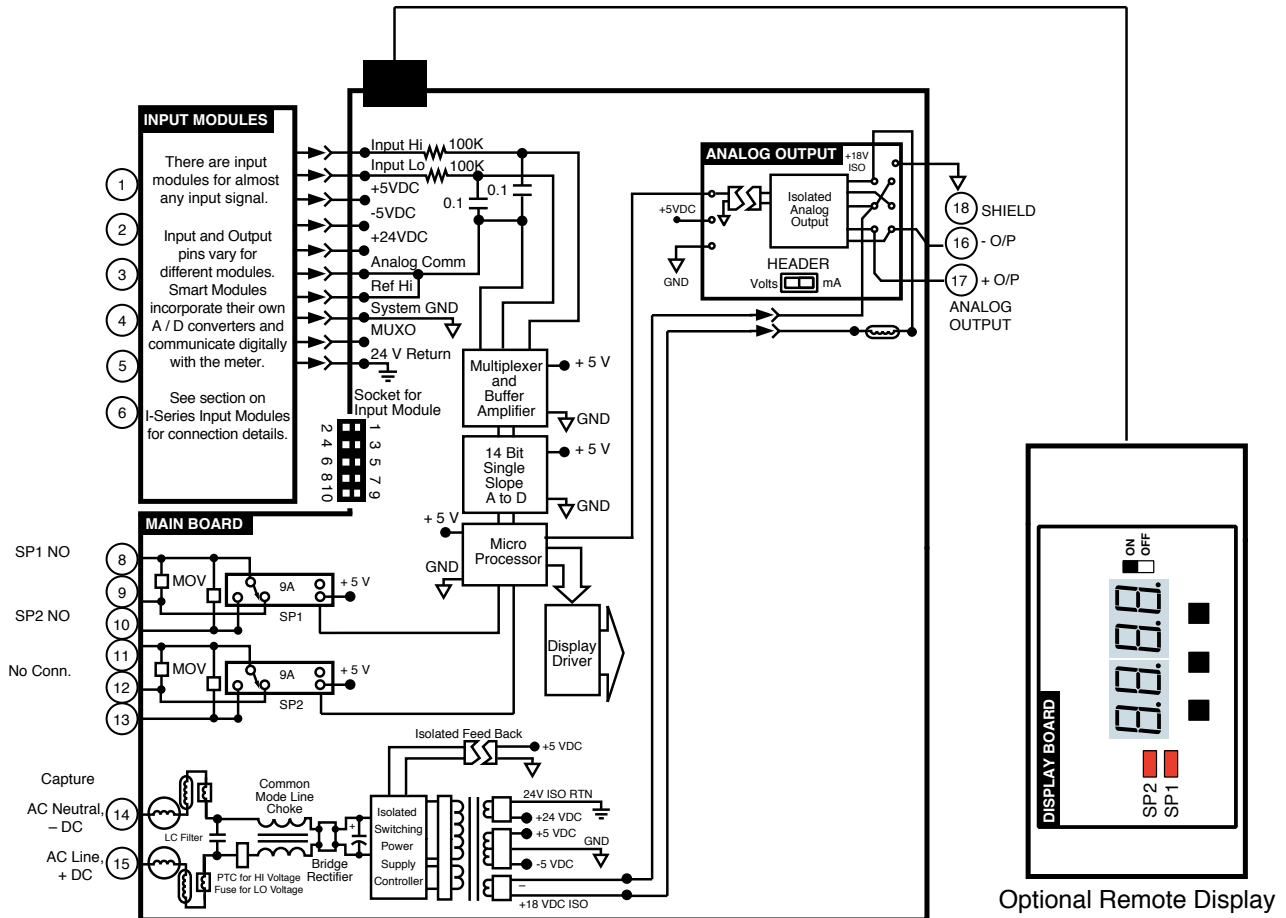

Connector Pinouts

Pinout Diagram

The Rear View of the Meter diagram shows the meter with the relay configuration: dual 10 Amp Form C and dual 5 Amp Form A relays. An analog output module is also shown as installed.

The TL Series Transmitter uses plug-in type screw terminal connectors for all input and output connections. The power supply connections (pins 14 and 15) have a unique plug and socket outline to prevent cross connection. The main board and input signal conditioner use right-angled connectors as standard. The output module uses straight-thru connectors as standard.



WARNING: AC and DC input signals and power supply voltages can be hazardous. Do Not connect live wires to screw terminal plugs, and do not insert, remove or handle screw terminal plugs with live wires connected.

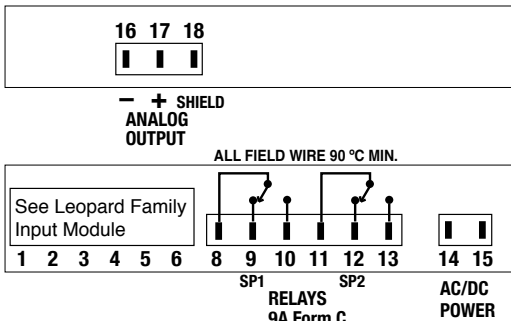

Auto-sensing AC/DC power supply. For voltages between 85-265 V AC / 95-300 V DC (PS1) or 15-48 V AC / 10-72 V DC (PS2).

Standard plug-in screw terminal connectors provided by Texmate:

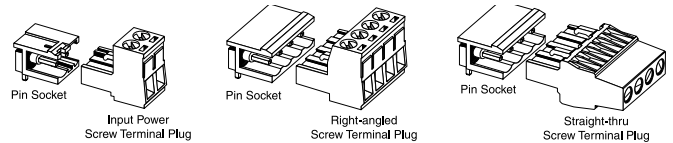

Input Signal – Pins 1 to 6

Pins 1 to 6 are reserved for the input signal conditioner. See the data sheet for the selected input signal conditioner.

Relay Output Pins- Pins 8 to 13

Pin 8-10 SP1 Normally Open
Pin 8-9 SP1 Normally Close
Pin 11-13 SP2 Normally Open
Pin 11-12 SP2 Normally Close

AC/DC Power Input- Pins 14 and 15

Auto-sensing AC/DC power supply. For voltages between 85-265 V AC/95-300 V DC (PS1) or 15-48 V AC/10-72 V DC (PS2).
Pin 14 AC/DC Neutral. Neutral power supply line.
Pin 15 AC/DC line. Live power supply line.

Analog Output- Pins 16 and 18

Pins 16 and 17 are the analog output pins on the optional output module. Their pin definitions are:

Pin 16 Negative (-) analog output.
Pin 17 Positive (+) analog output.
Pin 18 Shield.









I-Series Input Signal Conditioning Modules

Many additional input modules are available and others are constantly being developed. Check with your local distributor or www.texmate.com for updated information.

Pre-calibrated **I-Series** input modules, that have span or zero potentiometers, can be interchanged between any **I-Series** compatible meter, without recalibration, because all of the analog scaling and reference circuitry is self-contained within the module. Where appropriate, all the standard ranges shown are designed to be header selectable by the user, and Texmate's unique SPAN ADJUST Header facilitates scaling to almost any required engineering unit. See Input Module Component Glossary and Calibration on pages 13 and 14. Also see Two Point Digital Calibration and Digital Calibration on page 4.

Unless otherwise specified Texmate will ship all modules pre-calibrated with factory preselected ranges and/or scalings as shown in **BOLD** type. Other pre-calibrated standard ranges or custom ranges may be ordered. Factory installed custom scaling and other custom options are also available (see Ordering Information, Special Options on last page).

Symbols Indicate Module Compatibility Within Meter Families

 TIGER Family	 LEOPARD Family	 LYNX Family
 LEOPARD Family	 LYNX Family	 TIGER Family
 LYNX Family	 TIGER Family	 LEOPARD Family
ALL MODELS	SOME MODELS	MODEL SPECIFIC



WARNING: AC and DC input signals and power supply voltages can be hazardous. Do Not insert, remove or handle modules with live wires connected to any terminal plugs.

IA01: AC Volts Scaled RMS, 200/300V AC

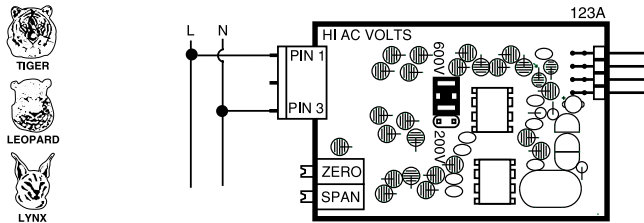

IA06: AC Volts True RMS, 300V AC

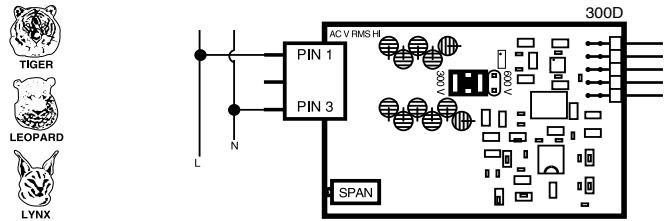

IA02: AC Volts Scaled RMS, 200mV/2V/20V AC

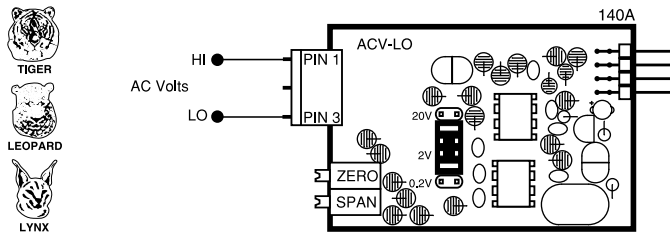

IA07: AC Volts True RMS, 200mV/2V/20V AC

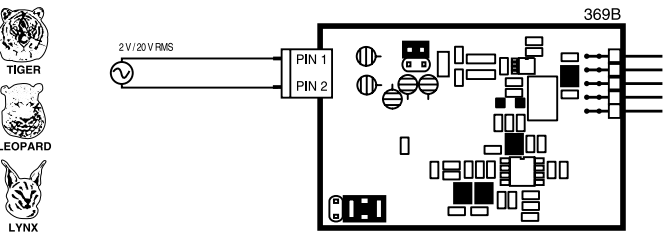

IA03: AC Milliamps Scaled RMS, 2/20/200mA AC

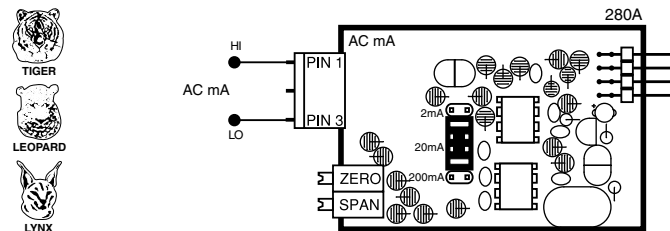

IA08: AC Milliamps True RMS, 2/20/200mA AC

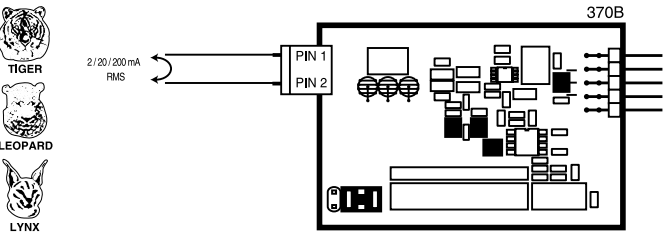

IA04: AC AC Amps Scaled RMS, 1 Amp AC

IA05: AC AC Amps Scaled RMS, 5 Amp AC

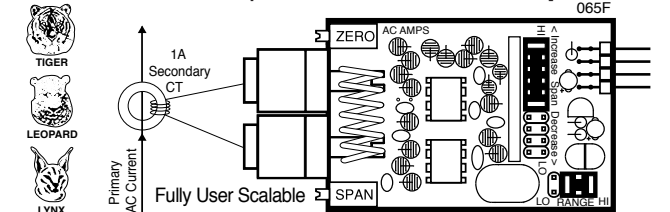

IA09: AC Amps True RMS, 1 Amp AC

IA11: AC Amps True RMS, 5 Amp AC

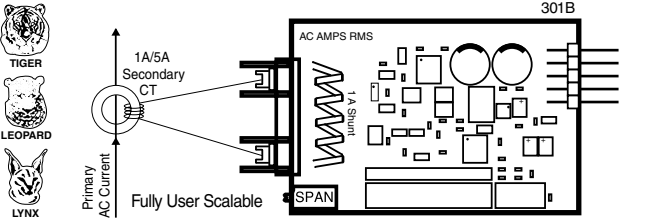

IA10: AC Millivolts, Scaled RMS, 100mV AC

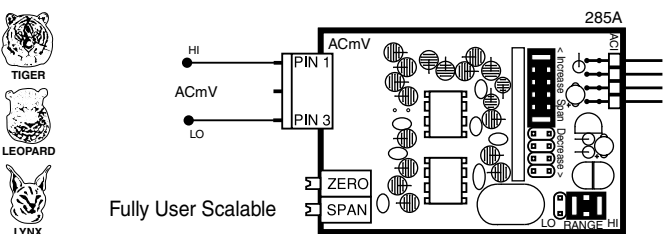

I-Series Input Signal Conditioning Modules

IA12: AC Millivolt RMS Sigma Delta

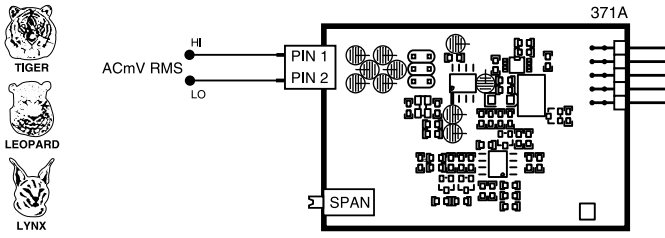

ID01: DC Volts, 2/20/200V/Custom w/24V DC Exc

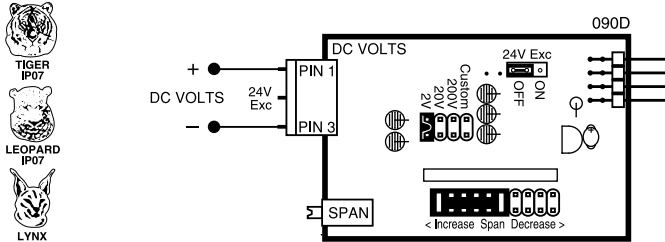

ID02: DC Millivolts, 20/50/100/200mV DC w/24V DC Exc

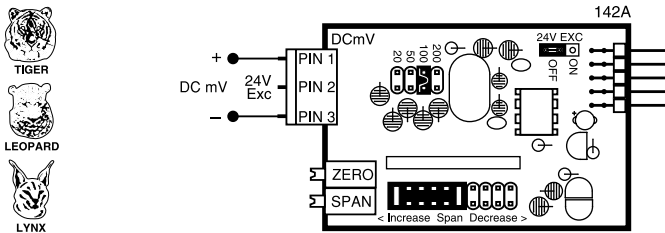

ID03: DC Milliamps, 2/20/200mA DC w/24V DC Exc

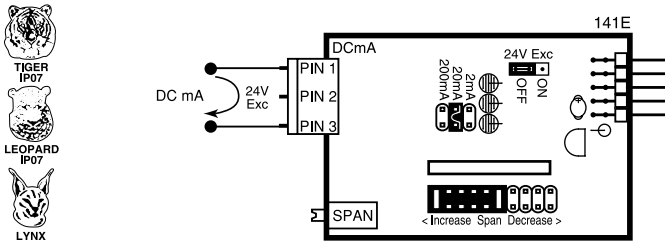

ID04: DC Amps, 5A DC

ID09: DC Amps, 1A DC

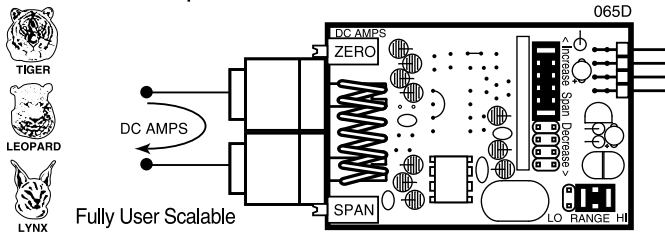

ID05: DC Volts 2/20/200/Custom V DC with Offset and 24V Exc.

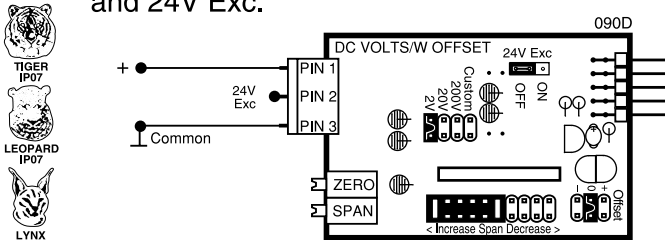

ID07: DC Milliamps, 2/20/200mA DC with Offset and 24V Exc

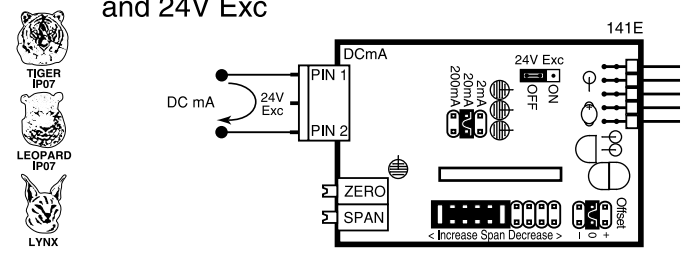

IP01: Process Loop, 4-20mA
IP02: Process Loop, 4-20mA with 24VDC EXC

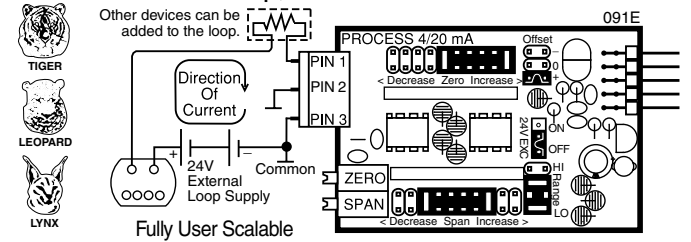

IP03: Process Input, 1-5V DC with Offset, 24V Exc

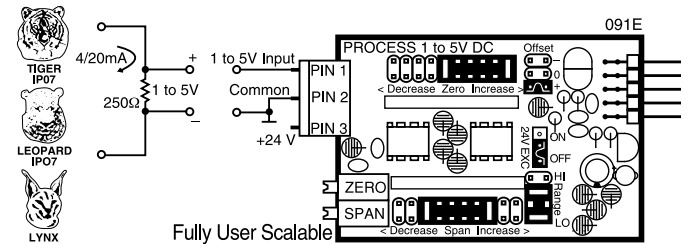

IP07: Universal Process Input
2V/5V/10V/20V/200V/2mA/20mA/Custom

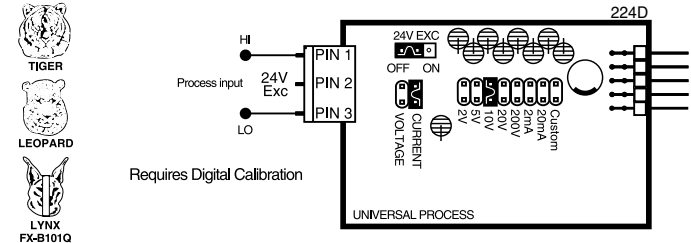

IR02: 3 wire Potentiometer 1KΩ min (0-F.S.)

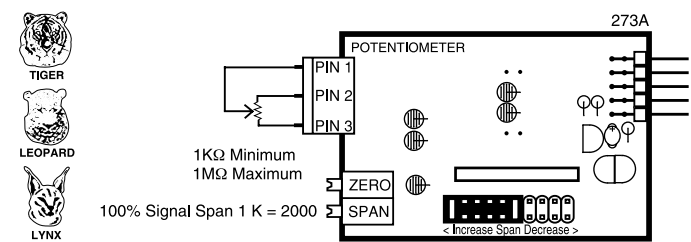

IR03: Linear Potentiometer 1KΩ min

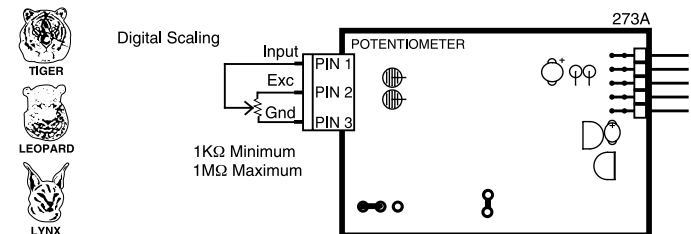

I-Series Input Signal Conditioning Modules

IR04: Resistance 2KΩ (Lynx only)
IR05: Resistance 2KΩ (Leopard only)

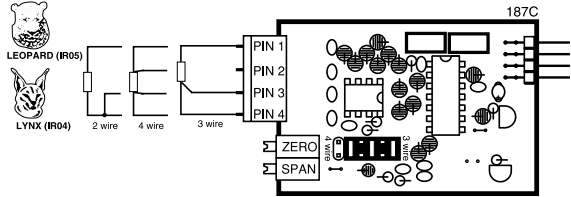

IS01: Strain Gage 5/10V DC Exc., 20/2mV/V, 4/6-wire

IS02: Pressure/Load Cell 5/10V DC Exc., 20/2mV/V, 4/6-wire

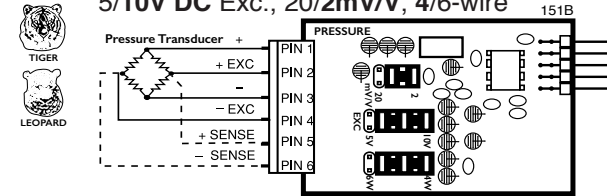

IS04: Pressure/Load Cell Ext Exc., 20/2mV/V, 4/6-wire

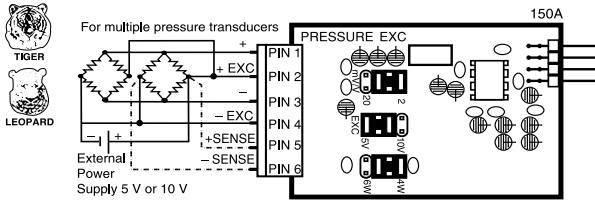

IS05: Pressure/Load Cell 20/2mV/V, 5/10V Exc 4-wire

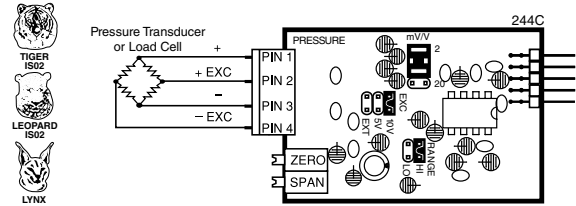

IS06: Pressure/Load Cell Ext Exc., 20/2mV/V, 4-wire

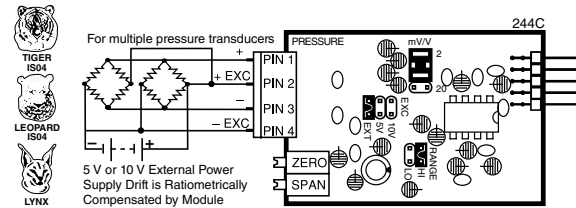

IS07: Pressure/Load Cell Ext Exc. High Impedance, 20/2mV/V, 4/6-wire

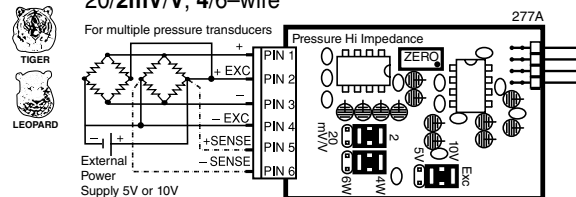

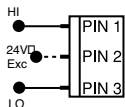

Input and Output Pins

On most modules Pin 1 is the Signal High input and Pin 3 is the Signal Low input. Typically Pin 2 is used for Excitation Voltage output.



24V DC Output Header

On some modules this header enables a 24V DC 25mA (max) Excitation/Auxiliary output to be connected to Pin 2.

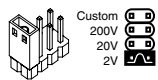

INPUT RANGE Header

Range values are marked on the PCB. Typically two to four positions are provided, which are selected with either a single or multiple jumper clip. When provided, a custom range position is only functional when the option has been factory installed.

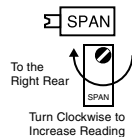

SPAN Potentiometer (Pot)

If provided, the 15 turn SPAN pot is always on the right side (as viewed from the rear of the meter). Typical adjustment is 20% of the input signal range.

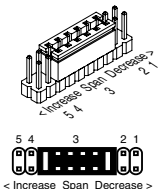

SPAN ADJUST Header

This unique five-position header expands the adjustment range of the SPAN pot into five equal 20% steps, across 100% of the input Signal Span. Any input Signal Span can then be precisely scaled down to provide any required Digital Display span from 1999 counts to 001 (one count).

SPAN Adjust Header position	1	2	3	4	5
SPAN Pot %	20%	20%	20%	20%	20%
Signal Span %	20%	40%	60%	80%	100%

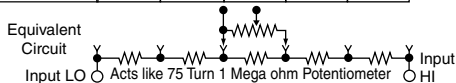

SPAN RANGE Header

When this header is provided it works in conjunction with the SPAN ADJUST Header by splitting its adjustment range into a Hi and a Lo range. This has the effect of dividing the adjustment range of the SPAN pot into ten equal 10% steps across 100% of the input Signal Span.

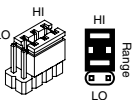

SPAN Adjust Header position	Span Range Header					Span Range Header				
	1	2	3	4	5	1	2	3	4	5
SPAN Pot %	10%	10%	10%	10%	10%	10%	10%	10%	10%	10%
Signal Span %	10%	20%	30%	40%	50%	60%	70%	80%	90%	100%

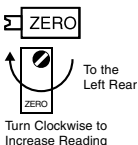
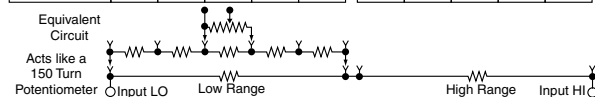

ZERO Potentiometer (Pot)

If provided, the ZERO pot is always to the left of the SPAN pot (as viewed from the rear of the meter). Typically it enables the input signal to be offset $\pm 5\%$ of full scale (-100 to +100 counts).

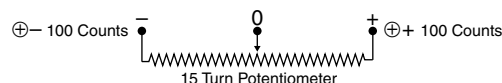

ZERO OFFSET RANGE Header

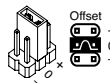

When provided, this three position header increases the ZERO pot's capability to offset the input signal, to $\pm 25\%$ of the digital display span. For example a Negative offset enables a 1 to 5V input to display 0 to full scale. The user can select negative offset, positive offset, or no offset (ZERO pot disabled for two step non-interactive span and offset calibration).

ZERO Pot %	- 100% of Offset	No Offset	+ 100% of Offset
Offset Range	- 500 Counts	Zero Pot Disabled	+ 500 Counts

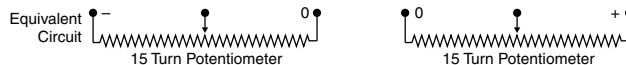

ZERO ADJUST Header

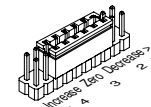

When this header is provided, it works in conjunction with the ZERO OFFSET RANGE Header, and expands the ZERO pot's offset capability into five equal negative steps or five equal positive steps. This enables virtually any degree of input signal offset required to display any desired engineering unit of measure.

ZERO Adjust Header position	Zero Offset Range Header					Zero Offset Range Header				
	5	4	3	2	1	1	2	3	4	5
ZERO Pot %	-20%	-20%	-20%	-20%	-20%	+20%	+20%	+20%	+20%	+20%
Offset Range	-1200 or more counts					+1200 or more counts				

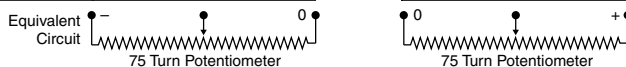

Input Module Analog Calibration

In addition to the analog calibration capabilities that enable many modules to be interchanged between different meters without loss of accuracy the Leopard Family of meters have enhanced Digital Calibration functions. See Page 4

Basic standard range calibration of direct reading modules that utilize either Auto Zero or a ZERO pot, an INPUT RANGE Header and or a SPAN pot.

- 1 If the module has an INPUT RANGE Header, reposition the jumper clip to select the desired input signal range.
2. Apply a zero input or short the input pins. The display will auto zero, or if the module has a ZERO pot, it should be adjusted until the display reads zero.
- 3 Apply a known input signal that is at least 20% of the full scale input range and adjust the SPAN pot until the display reads the exact input value. For negative inputs, Leopard Family Meters will display negative overrange at 50% of full scale range.
- 4 Decimal Points. The selection or positioning of decimal points has no effect on the calibration of the modules

Wide range scaling, in engineering units not requiring offsets, with modules that utilize auto-zero or a ZERO pot, a SPAN RANGE Header and or a SPAN ADJUST Header.

Texmate's unique SPAN ADJUST and SPAN RANGE Headers provide the circuit equivalent of an ultra-precision one megohm 75 or 150 turn potentiometer that can infinitely scale down any Input Signal SPAN to provide any full scale Digital Display Span from 1999 (counts) to 001 (one count).

If the module has an INPUT RANGE Header, and the required full

Input Module Calibration Procedures Continued

scale Digital Display Span (counts) is to be larger than the directly measured value of the input Signal Span, then the next lower range on the INPUT RANGE Header should be selected. The resulting over range Signal Span is then scaled down, by selecting the position of the SPAN RANGE Header and or the SPAN ADJUST Header, which will reduce the input Signal Span to a percentage, that the required Digital Display Span can be reached by calibration with the SPAN pot.

Example A: 0 to 10 V to read 0 to 1800 gallons.

Signal Span = 10V, Digital Display Span = 1800 counts

- 1 Select the 2 V INPUT RANGE Header position. This will provide a digital display of 1800 counts with an input of only 1.8 V which is $(1.8 \div 10) = 18\%$ of the examples 10 V Signal Span.
- 2 To scale down the Signal Span to 18% select the 20% Signal Span position on the SPAN ADJUST Header (position 1) or if the module has a SPAN RANGE Header, select (LO Range) and 20% Signal Span position on the SPAN ADJUST Header (position 2).
- 3 Apply a zero input or short the input pins. The display will auto zero, or if the module has a ZERO pot, it should be adjusted until the display reads zero.
- 4 Apply 10 V and adjust the SPAN pot until the display reads 1800.

Large offset scaling and calibration of process signal inputs with modules that utilize ZERO ADJUST Headers and or ZERO OFFSET RANGE Headers.

Texmate's unique ZERO OFFSET RANGE Header enables the use of a simple two step scaling and calibration procedure for those process signals that require large offsets. This eliminates the back and forth interaction, between zero and span settings, that is often required to calibrate less finely engineered products.

The first step is to set the ZERO OFFSET RANGE Header to the center position (No Offset) and scale down the Input Signal Span to a percentage that will enable calibration with the SPAN pot to reach the required Digital Display Span.

The second step is to set the ZERO ADJUST and or ZERO OFFSET RANGE Header to provide a positive or negative offset of sufficient counts that calibration with the ZERO pot will offset the Digital Display Span to produce the required digital reading.

Example B: 1 to 5 V to read -100 to 1500 °C.

Signal Span = 4V, Digital Display Span = 1600 counts

- 1 If the module has an INPUT RANGE Header the 2 V position should be selected. This will provide a digital display of 1600 counts for an input of 1.6 V which is $(1.6 \div 4) = 40\%$ of the examples 4 V signal span. To scale down the Signal Span to 40% select the 40% Signal Span position on the SPAN ADJUST Header (position 2).
- 2 If the module is a Process Input 1-5 V DC type, select the (Hi Range) position on the SPAN RANGE Header and the 100% Signal Span position on the SPAN ADJUST Header (position 5, max increase). This will provide a digital display of 1600 counts for an input of 4V which is 100% of the examples 4V Signal Span.
- 3 Set the ZERO OFFSET RANGE Header to the center position (no offset). Apply 1 V and adjust the SPAN pot until the display reads 400 . A 4V input would then read 1600 counts.
- 4 Set the ZERO OFFSET RANGE Header to the negative offset position. If the module has a ZERO ADJUST Header select the position that will provide a negative offset of ≈ -500 counts. Apply 1 V and adjust the ZERO pot until the display reads -100. Apply 5 V and check that the display reads 1500.

Example C: 4 to 20 mA to read 00.0 to +100.0%

Signal Span = 16 mA, Digital Display Span = 1000 counts.

- 1 The full scale Signal Span of the Process Input 4-20 mA modules is 0 to 20 mA for a full scale Digital Display Span of 0 to 2000 counts. This will provide a digital display of 1000 counts with an input of only 10 mA which is $(10 \div 16) = 62.5\%$ of the examples 16 mA signal span.
- 2 To scale down the Signal Span to 62.5% select the (Hi Range) Position on the Span Range Header and the 70% Signal Span position on the SPAN ADJUST Header (position 2).
- 3 Set the ZERO OFFSET RANGE Header to the center position (no offset). Apply 4 mA and adjust the SPAN pot until the display reads 250 . A 16 mA input would then read 1000 counts.
- 4 Set the ZERO OFFSET RANGE Header to the positive offset position. If the module has a ZERO ADJUST Header select the position that will provide a negative offset of ≈ -250 counts. Apply 4 mA and adjust the ZERO pot until the display reads 000. Apply 20 mA and check that the display reads 1000. Select decimal point XXX·X to display 00.0 to 100.0.

Case Dimensions

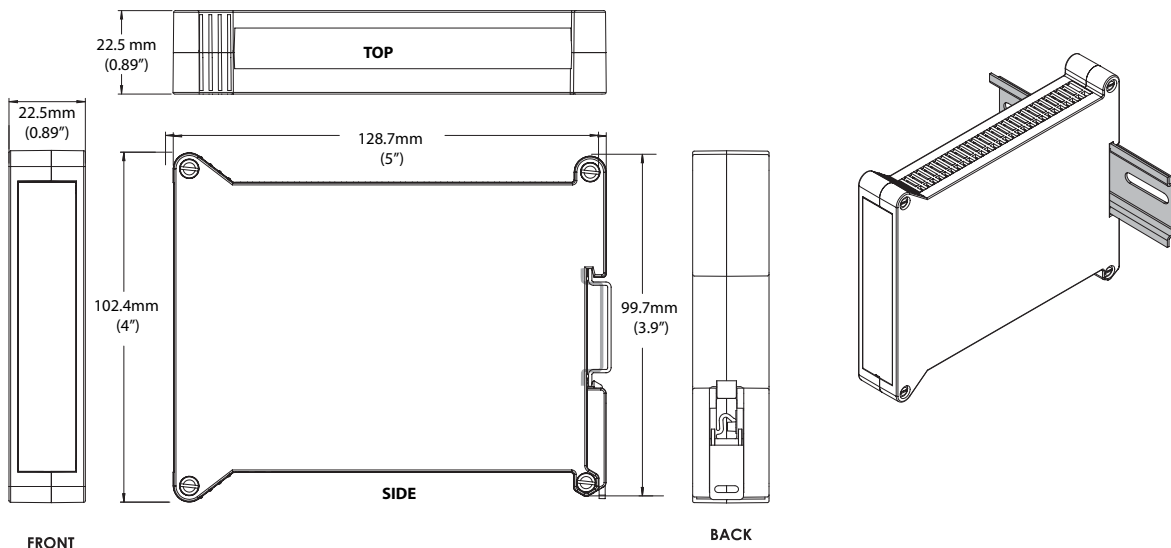

Installation

1. Install and wire transmitter per local applicable codes/regulations, the particular application, and good installation practices.
2. Install transmitter in a location that does not exceed the maximum operating temperature and that provides good air circulation.
3. Separate input/output leads from power lines to protect the transmitter from external noise. Input/output leads should be routed as far away as possible from contactors, control relays, transformers and other noisy components. Shielding cables for input/output leads is recommended with shield connection to earth ground near the meter preferred.
4. A circuit breaker or disconnect switch is required to disconnect power to the meter. The breaker/switch should be in close proximity to the meter and marked as the disconnecting device for the meter or meter circuit. The circuit breaker or wall switch must be rated for the applied voltage (e.g., 120VAC or 240VAC) and current appropriate for the electrical application (e.g., 15A or 20A).
5. See *Connector Pinouts section* for wiring.
6. Use 28-12 AWG wiring, minimum 90°C (HH) temperature rating. Strip wire approximately 0.3 in. (7-8 mm).
7. Recommended torque on all terminal plug screws is 4.5 lb-in (0.51 N-m).



